

Seventy Years of Radar and Communications: The Road from Separation to Integration

Fan Liu, *Member, IEEE*, Le Zheng, *Senior Member, IEEE*, Yuanhao Cui, *Member, IEEE*,
Christos Masouros, *Senior Member, IEEE*, Athina P. Petropulu, *Fellow, IEEE*,
Hugh Griffiths, *Fellow, IEEE*, and Yonina C. Eldar, *Fellow, IEEE*

Abstract—Radar and communications (R&C) as key utilities of electromagnetic (EM) waves have fundamentally shaped human society and triggered the modern information age. Although R&C have been historically progressing separately, in recent decades they have been moving from separation to integration, forming integrated sensing and communication (ISAC) systems, which find extensive applications in next-generation wireless networks and future radar systems. To better understand the essence of ISAC systems, this paper provides a systematic overview on the historical development of R&C from a signal processing (SP) perspective. We first interpret the duality between R&C as signals and systems, followed by an introduction of their fundamental principles. We then elaborate on the two main trends in their technological evolution, namely, the increase of frequencies and bandwidths, and the expansion of antenna arrays. Moreover, we show how the intertwined narratives of R&C evolved into ISAC, and discuss the resultant SP framework. Finally, we overview future research directions in this field.

I. INTRODUCTION

A. Background and Motivation

Since the 20th century, the development of human civilization has relied largely upon the exploitation of electromagnetic (EM) waves. Among many applications, EM waves have enabled information acquisition and delivery, which form the foundation of our modern information era, and have given rise to the proliferation of radar and communication (R&C) technologies. Despite the fact that both technologies originated from the discoveries of Maxwell and Hertz, R&C have been treated as two separate research fields due to different constraints in their respective applications, and were therefore independently investigated and developed for decades.

Historically, the technological evolution of R&C follows along two main trends: a) from low frequencies to higher frequencies and larger bandwidths [1], and b) from single-antenna to multi-antenna or even massive-antenna arrays [2],

(Corresponding author: Le Zheng)

F. Liu is with the Southern University of Science and Technology, Shenzhen, China (e-mail: liuf6@sustech.edu.cn).

L. Zheng is with the Beijing Institute of Technology (BIT), Beijing, China (e-mail: le.zheng.cn@gmail.com).

Y. Cui is with the Beijing University of Posts and Telecommunications, Beijing, China (e-mail: cuiyuanhao@bupt.edu.cn).

C. Masouros and H. Griffiths are with the University College London, London, WC1E 7JE, UK (e-mail: chris.masouros@ieee.org, h.griffiths@ucl.ac.uk).

A. P. Petropulu is with the Rutgers, the State University of New Jersey, 94 Brett Road, Piscataway, NJ 08854, United States (e-mail: athina@rutgers.edu).

Y. C. Eldar is with the Weizmann Institute of Science, Rehovot, Israel (e-mail: yonina.eldar@weizmann.ac.il).

[3]. With recent developments, the combined use of large-antenna arrays and Millimeter Wave (mmWave)/Terahertz (THz) band signals results in striking similarities between R&C systems in terms of the hardware architecture, channel characteristics, as well as signal processing methods. Hence, the boundary between R&C is becoming blurred, and the hardware and spectrum convergence has led to a design paradigm shift, where the two systems can be co-designed for efficiently utilizing resources, offering tunable tradeoffs and unprecedented synergies between them to enable mutual benefits. This line of research is typically referred to as integrated sensing and communications (ISAC), and has been applied in numerous emerging areas, including vehicular networks, IoT networks, and activity recognition [4]. Over the last decade, ISAC has been well-recognized as a key enabling technology for both next-generation wireless networks and radar systems [4]. Given the potential of ISAC, deeper understanding of the various connections and distinctions between R&C, and learning from how they evolved from separation to integration, is important for inspiring future research.

B. Basic Principles: A Signals-and-Systems Perspective

Governed by Maxwell's equations, EM waves are capable of travelling over large distances at the speed of light, making them a perfect information carrier. In general, one may leverage EM waves to acquire the information of physical targets, including range, velocity, and angle, through wireless sensing, or to efficiently deliver artificial information, e.g., texts, voices, images, and videos from one point to another via wireless communications. These principles constitute the fundamental rationale of R&C.

The basic system setting for both R&C consists of three parts: a transmitter (Tx) that produces EM waves, a channel where EM waves propagate, and a receiver (Rx) that receives EM waves distorted by the channel. It is often convenient to represent EM waves by the electrical field intensity, as a complex signal of time t . The core tasks for R&C can then be defined as:

- **Information Acquisition for Radar:** To extract the target information contained in the channel from the received signal, given knowledge of the transmit signal.
- **Information Delivery for Communications:** To recover the useful information contained in the transmit signal at the Rx, with knowledge of the channel response.

By denoting the signals at the Tx and Rx at time t as $s(t)$ and $y(t)$, respectively, the propagation of the signal within

the channel can be modeled as a mapping from its input $s(t)$ to the output $y(t)$. Ideally, if the noise and disturbance are not considered, such a mapping is *linear* due to the physical nature of EM fields and waves, or equivalently, owing to the linearity of Maxwell's equations. Furthermore, if the channel characteristics remain unchanged within a certain time period, it can be approximated as a linear time-invariant (LTI) system, characterized by its impulse response $h(t)$. As such, the linear mapping is expressed as a convolution integral $y(t) = s(t) * h(t)$. Under the Nyquist criterion, $y(t)$ can be sampled in a lossless manner, expressed as a convolution sum $y(n) = s(n) * h(n)$ at the n th sampling point. Let $\mathbf{s} = [s(0), \dots, s(N-1)]^T$ be the Tx signal with length N , $\mathbf{h} = [h(0), \dots, h(P-1)]^T$ be the channel impulse response with length P , and $\mathbf{y} = [y(0), \dots, y(N+P-2)]^T$ be the Rx signal with length $N+P-1$. Then the convolution can be recast as $\mathbf{y} = \mathbf{H}\mathbf{s}$, where $\mathbf{H} = \text{Toep}(\mathbf{h}) \in \mathbb{C}^{(N+P-1) \times N}$ is a Toeplitz matrix, with the n th column being $[\mathbf{0}_{n-1}^T, \mathbf{h}^T, \mathbf{0}_{N-n+1}^T]^T$. Alternatively, one may express the convolution as $\mathbf{y} = \mathbf{S}\mathbf{h}$ by the commutative property, where $\mathbf{S} = \text{Toep}(\mathbf{s}) \in \mathbb{C}^{(N+P-1) \times P}$.

The above duality between interchangeable signals and systems implies an interesting connection between R&C. From the communication perspective, the process that the Tx signal passing through a channel may be viewed as a linear transform \mathbf{H} applied to \mathbf{s} , and the communication task is to recover the information embedded in \mathbf{s} by receiving \mathbf{y} . From the radar perspective, the sensing task is to recover target parameters embedded in \mathbf{h} , an input "signal", by observing \mathbf{y} , an output signal linearly transformed from \mathbf{h} through a "system" \mathbf{S} . This reveals that the basic SP problems in R&C are mathematically similar.

C. Linear Gaussian Models

Let us further investigate the more general linear Gaussian signal model by taking additive white Gaussian noise (AWGN) into consideration, which is

$$\mathbf{Y} = \mathbf{H}(\boldsymbol{\eta}) \mathbf{S}(\boldsymbol{\xi}) + \mathbf{Z}, \quad (1)$$

where \mathbf{Y} and \mathbf{S} are sampled receive and transmit signals, which could be defined over multiple domains, e.g., time-space or time-frequency domain, \mathbf{H} is the corresponding channel matrix (not necessarily Topelitz), and \mathbf{Z} is the white Gaussian noise signal with variance σ^2 . The channel \mathbf{H} is a function of the physical parameters $\boldsymbol{\eta}$, e.g., range, angle, and Doppler. The transmit signal \mathbf{S} may be encoded/modulated with some information codewords $\boldsymbol{\xi}$. Model (1) represents many R&C systems as elaborated below.

- **Radar Signal Model:** Radar systems aim at extracting target parameters $\boldsymbol{\eta}$ from \mathbf{Y} . For both radar Tx and Rx, \mathbf{S} is typically a known deterministic signal, in which case $\boldsymbol{\xi}$ can be omitted since the radar waveform contains no information. This can be expressed as

$$\mathbf{Y}_r = \mathbf{H}_r(\boldsymbol{\eta}) \mathbf{S}_r + \mathbf{Z}_r. \quad (2)$$

- **Communication Signal Model:** Communication systems aim at recovering codewords $\boldsymbol{\xi}$ from \mathbf{Y} . The channel \mathbf{H} ,

which is sometimes regarded as an unstructured matrix, can be estimated *a priori* via pilots. Therefore, knowing $\boldsymbol{\eta}$ may not be the first priority. The resulting model is

$$\mathbf{Y}_c = \mathbf{H}_c \mathbf{S}_c(\boldsymbol{\xi}) + \mathbf{Z}_c. \quad (3)$$

The subscripts $(\cdot)_r$ and $(\cdot)_c$ are to differentiate R&C signals, channels, and noises, respectively. We highlight that (2) and (3) describe a variety of R&C signal models. For example, (2) can be viewed as the target return of a multi-input multi-output (MIMO) radar in a given range-Doppler bin, where $\boldsymbol{\eta}$ represents angles of targets. Accordingly, (3) may be considered as a narrowband MIMO communication signal. Alternatively, both (2) and (3) can be viewed as orthogonal frequency-division multiplexing (OFDM) signal models for R&C, respectively. In the sequel, we do not specify the signal domain but focus on generic models (2) and (3). More concrete signal models will be discussed in Secs. III-IV. In addition to individual R&C systems, (1) may also characterize the general ISAC signal model. That is, a unified ISAC signal serves for dual purposes of information delivering and target sensing, whereas R&C channels may differ from each other. More details on ISAC systems will be discussed in Sec. V.

D. Contributions of the Paper

In this paper, we provide a systematic overview on the development and key milestones achieved in the history of R&C from an SP perspective. We commence by introducing the early development of R&C and their fundamental principles. We then present the spectrum engineering of R&C, namely, from narrowband to wideband, and from single-carrier to multi-carrier systems. Furthermore, we elaborate on the expansion of R&C systems' antenna arrays, i.e., from single-antenna systems, to phased-array systems, and to MIMO, massive MIMO (mMIMO), and distributed antenna systems. Following the above two technological trends, the paths of R&C eventually move from separation to integration, and give birth to the ISAC technology, which motivates the detailed discussion on the SP framework of ISAC. Finally, we summarize the paper and identify future research directions.

II. FUNDAMENTALS OF RADAR AND COMMUNICATIONS

A. Early Developments

While the existence of EM waves was theoretically predicted by Maxwell in 1865, and experimentally verified by Hertz in 1887, its capability of carrying information to travel long distances was not validated until Marconi's transatlantic wireless experiment in 1901. The successful reception of the first transatlantic radio signal marked the beginning of the great information era. From then on, communication technology has rapidly grown thanks to the heavy demand for intelligence, intercept and cryptography technologies during the two world wars. It is generally difficult to identify a precise date for the birth of radar. Some of the early records showed that the German inventor C. Hülsmeyer was able to use radio signals to detect distant metallic objects as early as 1904. In 1915, the British radar pioneer Sir Robert Watson Watt, employed radio signals to detect thunderstorms and lightning.

The R&D of modern radar systems was not carried out until the mid 1930s. The term RADAR was first used by the US Navy as an acronym of “RADio Detection And Ranging” in 1939.

In Fig. 1 we summarize key milestones achieved in the R&C history, which are split into four categories with different markers, namely, individual R&C technologies, general technologies that are useful for both, and ISAC technologies. In the remainder of the paper, we will discuss how these key techniques facilitate the development of R&C and ISAC systems.

B. Fundamental Signal Processing Theories

Theoretical research on R&C was established in the late 1940s. Below we elaborate on the fundamental SP theories of R&C, and in particular focus on models (2) and (3).

1) *Signal Detection*: Signal detection problems arise from many R&C applications. One essential task for radar is to determine whether a target exists by observing \mathbf{Y}_r , modeled as a binary hypothesis testing (BHT) problem

$$\mathbf{Y}_r = \begin{cases} \mathcal{H}_0 : \mathbf{Y}_r = \mathbf{Z}_r, \\ \mathcal{H}_1 : \mathbf{Y}_r = \mathbf{H}_r(\boldsymbol{\eta}) \mathbf{S}_r + \mathbf{Z}_r, \end{cases} \quad (4)$$

where \mathcal{H}_0 represents the null hypothesis, i.e., the radar receives nothing but noise, and \mathcal{H}_1 stands for the hypothesis where radar receives both the target return and the noise. To resolve the BHT problem above, one needs to design a *detector* $\mathcal{T}(\cdot)$ that maps the received signal \mathbf{Y}_r to a real number, and then compares the output with a preset threshold γ , thus to determine which hypothesis to choose as true. A good target detector should maximize the detection probability $P_D = \Pr(\mathcal{H}_1 | \mathcal{H}_1)$, while maintaining a low false-alarm probability $P_{FA} = \Pr(\mathcal{H}_1 | \mathcal{H}_0)$, following the Neyman-Pearson (NP) criterion [5].

Signal detection also plays a critical role at the communication Rx. In (3), the communication Rx observes $\mathbf{Y}_c = \mathbf{H}_c \mathbf{S}_c(\boldsymbol{\xi}) + \mathbf{Z}_c$, and seeks to yield an estimate $\hat{\boldsymbol{\xi}}$ of the information symbol vector $\boldsymbol{\xi} = [\xi_1, \xi_2, \dots, \xi_N]^T \in \mathcal{A}$. This can be modeled as a multiple hypothesis test (MHT), and solved by leveraging the minimum error probability (MEP) criterion. That is, to minimize the error probability $P_e = \sum_{i=1}^{|\mathcal{A}|} \Pr(\hat{\xi}_i \neq \xi_i) \Pr(\xi_i)$, where $|\mathcal{A}|$ is the cardinality of \mathcal{A} . The MEP criterion can be translated to the MAP criterion, i.e., the recovered symbols should be the maximizer of the *a posteriori* probability. Note that the decision region in the MEP criterion for communication symbols is determined by their *a priori* probability, while the decision thresholds in the NP criterion for radar is determined by the required false-alarm probability, resulting in different designs for R&C detectors.

2) *Parameter Estimation*: Parameter estimation represents another category of basic SP technique in R&C systems. For radar systems, once a target is confirmed to be present, it needs to further extract its parameters $\boldsymbol{\eta}$ from \mathbf{Y}_r by conceiving an *estimator*, mapping \mathbf{Y}_r from the signal space to an estimate $\hat{\boldsymbol{\eta}}$, defined as $\hat{\boldsymbol{\eta}} = \mathcal{F}(\mathbf{Y}_r)$. To measure how accurate an estimator is, a key performance metric is the mean squared error (MSE), expressed as $\varepsilon = \mathbb{E}(\|\boldsymbol{\eta} - \hat{\boldsymbol{\eta}}\|^2)$. The average may be over

the noise or also over the parameters if they are assumed random. When the parameters are assumed to be deterministic, the MSE of any unbiased estimate is lower-bounded by the Cramér-Rao bound (CRB), defined as the inverse of the Fisher information matrix \mathbf{J} [5]

$$\mathbb{E}[(\boldsymbol{\eta} - \hat{\boldsymbol{\eta}})(\boldsymbol{\eta} - \hat{\boldsymbol{\eta}})^H] \succeq \mathbf{J}^{-1} = \left\{ -\mathbb{E} \left[\frac{\partial^2 \ln p(\mathbf{Y}_r; \boldsymbol{\eta})}{\partial \boldsymbol{\eta}^2} \right] \right\}^{-1}, \quad (5)$$

where $p(\mathbf{Y}_r; \boldsymbol{\eta})$ is the probability density function (PDF) of \mathbf{Y}_r parameterized by $\boldsymbol{\eta}$.

In communication systems, the channel \mathbf{H}_c should be estimated before delivering the useful information. The basic rationale of channel estimation is that the Tx sends pilots to the Rx, which are reference signals known to both. The Rx then estimates the channel based on the knowledge of both received signals and pilots. Indeed, channel estimation is mathematically similar to the target estimation problem, where the to-be-estimated parameters $\boldsymbol{\eta}$ are entries of \mathbf{H}_c , which is regarded as an unstructured matrix.

3) *Information Theory*: Information theory is the fundamental principle of communications. A remarkable result attained by C. E. Shannon in his landmark paper published in 1948 [6] states that, for any discrete memoryless channel (DMC) with input X and output Y , its *capacity* is $C = \max_{p(X)} I(X; Y)$, where the maximum is taken over all possible input distribution $p(X)$, and $I(X; Y)$ is the mutual information (MI) between X and Y . The channel coding theorem states that a coding rate R below C is achievable. Conversely, if $R > C$, arbitrarily small decoding error is not possible.

Information theory may also be adopted to measure the radar performance [7]. Consider again a Gaussian channel with input X and output Y , and denote the input-output MI and minimum MSE (MMSE) as functions of the SNR. Then we have $\frac{d}{d \text{snr}} I(\text{snr}) = \text{MMSE}(\text{snr})$ [8]. That is, the increasing rate of the MI between X and Y with respect to the SNR is the MMSE for estimating X given Y . Since the MI always grows at a logarithm scale, its derivative (MMSE) reduces by increasing SNR. In radar systems, maximizing the MI often leads to minimizing the MMSE for estimating target parameters.

C. Interplay between R&C - General Connections

While communication happens between a pair of cooperative Tx and Rx, radar sensing is essentially uncooperative, even if the radar Tx and Rx are colocated. This distinction results in inherently different R&C SP frameworks. First, both R&C signal processing aims at recovering the useful information contained in the received signal with minimum distortion. The communication system, however, needs another level of performance guarantee, i.e., to transmit, receive, and actively control as much information as possible. This requires sophisticatedly tailored encoding & decoding, modulation & demodulation strategies at the Tx and Rx, respectively, which motivates the development of information theory, whose spirit forms the foundation of modern communication SP framework. Moreover, as the communication Tx and Rx are highly

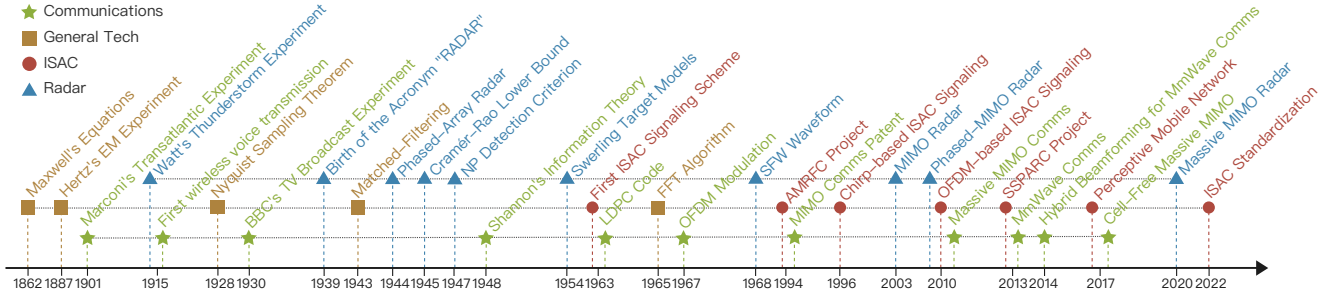

Fig. 1. Important milestones for radar and communications signal processing.

cooperative, they are able to share the SP complexities in a rather flexible manner, depending on the specific scenarios. For instance, in a downlink communication setup where powerful base station (BS) sends information to the user, most of the complicated signal processing is done at the Tx's side, e.g., precoding, thus to ease the computational burden at the user's side. In a radar system, however, the complexity of the Rx SP always dominates its Tx counterpart, yet they are unable to share design complexities, since the Tx needs not to encode any information for the Rx.

In what follows, we elaborate on the evolution of R&C in terms of both the spectrum engineering and antenna array technologies, and further reveal their interplay in the spectral and spatial SP.

III. SPECTRUM ENGINEERING: THE ROAD TO HIGHER FREQUENCY AND LARGER BANDWIDTH

A. Spectrum Characteristics and Management

The radio-frequency (RF) EM spectrum, extending from below 1 MHz to above 100 GHz, has been used for a wide range of applications, including communications, radio and television broadcasting, radio-navigation, and sensing [9]. Fig. 2 lists the frequency bands where R&C systems operate and highlights the modes and usage that are performed in each band. For radar sensing, the lower bands offer some unique capabilities such as long-range surveillance and weather monitoring [9]. For communications, lower bands exhibit low signal attenuation, making them suitable for long-distance communications.

The higher frequency bands provide some advantages to R&C. For a fixed fractional bandwidth, increasing the operating frequency subsequently increases the achievable bandwidth, thus providing finer range resolution for radar and higher data rates for communications. However, in these higher bands, long-range operation becomes more strongly affected by attenuation due to the atmosphere. As such, radar sensing and wireless communication via these bands are limited to short-range applications.

As a representative wideband signaling strategy, multi-carrier technologies have been extensively applied in both R&C systems, which we overview in the following.

B. Signal Models and Processing Techniques

1) *Multi-Carrier Radar Signal Processing*: Let us consider a pulsed radar, with a non-zero support $[0, \tau]$ for each pulse. The pulse repetition interval (PRI) is T_{PRI} and the total transmit bandwidth available at the baseband is B_r , resulting in a duty cycle of τ/T_{PRI} . The carrier frequency f_n of the n th pulse is chosen from $[f_c - \Delta B/2, f_c + B_r - \Delta B/2]$ for the multi-carrier radar system, where f_c is the lowest carrier frequency within the band, and ΔB is the bandwidth of each subpulse. Specifically, for single-carrier systems, we have $f_n = f_c, \forall n$ with $f_c \gg B_r$. The n th transmit pulse is $s_{r,n}(t) = \sqrt{P_r} x_r(t - nT_{\text{PRI}}) e^{j2\pi f_n(t - nT_{\text{PRI}})}$, where P_r is the radar transmit power. For the linear frequency modulated (LFM) waveform, we have $x_r(t) = e^{j\pi B_r t^2/\tau} \text{rect}(t/\tau)$, where $\text{rect}(t/\tau)$ is 1 for $0 \leq t \leq \tau$, and 0 elsewhere. For a phase modulated (PM) waveform, the continuous-time baseband signal is given by $x_r(t) = \sum_{p=0}^{N_p-1} \bar{x}_r(p) \psi_r(t - pT_r)$ with $N_p T_r = \tau$ and $\bar{x}_r(p)$ being the p -th code. Here, $\psi_r(\cdot)$ is a Nyquist waveform of bandwidth $\Delta B = 1/T_r$, i.e., such that its auto-correlation $R_\psi(\cdot)$ satisfies the condition $R_\psi(kT_r) = \delta(k)$, with $\delta(\cdot)$ denoting the Kronecker delta and $1/T_r$ the fast-time coding rate. The target response is $h(t) = \sum_{l=0}^{L-1} \alpha_l e^{j2\pi \nu_l t} \bar{\delta}(t - \tau_l)$, where $\bar{\delta}(\cdot)$ is the Dirac delta function, α_l is the reflection coefficient, τ_l and ν_l are the delay and Doppler of the l -th target corresponding to its range and velocity.

In 1968, K. Rutenburg and L. Ghanzi proposed the stepped frequency waveform (SFW) that can be viewed as a form of inter-pulse phase coding [10]. SFW was later used in sets of radars, in which coherent integration of a burst of pulses yields high range resolution. Conventional SFW sets the carrier frequency sequence as $f_n = f_c + n\Delta f, \forall n$. To improve the data rate and avoid interference, more recent approaches randomly draw frequencies from the set $\mathcal{F} = \{f_n | f_n = f_c + d_n \Delta f\}$, where Δf is the frequency step size, $d_n \in \mathbb{Z}$ is chosen from a subset of $[0, D]$ so that $D\Delta f > B$ is the synthesized bandwidth.

Conventional SFW signal processing follows the matched-filtering (MF) process, in which \mathbf{Y}_r , \mathbf{S}_r , and $\mathbf{H}_r(\boldsymbol{\eta})$ are the Rx and Tx signals, and target response in the frequency domain, respectively. With this, we may represent the discretized signal as $\mathbf{y} = \mathbf{S}\mathbf{h} + \mathbf{z}$, with \mathbf{h} being the time-domain target response and \mathbf{S} being the Toeplitz matrix composed of the transmitted signal. For sparse SFW, MF technique leads to high sidelobes due to the vacancy in frequency bands. Noticing that the targets

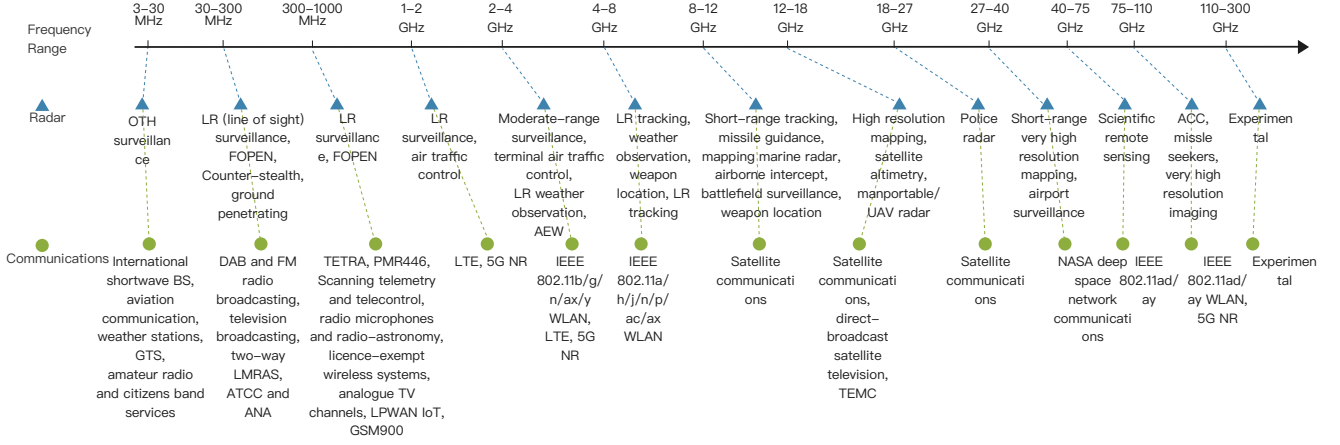

Fig. 2. Summary of frequency bands and their usage in R&C applications. *Abbreviations:* Airborne Early Warning (AEW), Automobile Cruise Control (ACC), Unmanned Aerial Vehicle (UAV), Long-Range (LR), Foliage Penetration (FOPEN), Ground Penetrating Radar (GPR), Over-the-Horizon (OTH), Base Station (BS), Air Traffic Control Communications (ATCC), Land Mobile Radio Systems (LMRAS), Terrestrial Trunked Radio (TETRA), Terrestrial Microwave Communications (TEMC), Government Time Stations (GTS), Air Navigation (ANA).

are usually composed of very few scatterers compared with the number of measurements, we are tempted use sparse recovery methods to estimate \mathbf{h} . Consider an optimization problem

$$\min_{\mathbf{h}} \|\mathbf{h}\|_0 \text{ s.t. } \|\mathbf{y} - \mathbf{S}\mathbf{h}\|_2 \leq \zeta, \quad (6)$$

where ζ is a positive constant dependent on the noise variance. This problem can be solved using compressed sensing (CS) algorithms, e.g., ℓ_1 -norm minimization [11].

2) *Multi-Carrier Communication Signal Processing:* As for the communication system, we assume it occupies a frequency band of B_c . Setting $T_c = \frac{1}{B_c}$, the radiated signal is given by $s_c(t) = \sum_{n=0}^{N_s-1} \sqrt{P_c} x_c(n) \psi_c(t - nT_c) e^{j2\pi f_c t}$, where P_c is the transmit power, $x_c(n)$, $\forall n$ is the symbol sequence to be transmitted with length N_s , and $\psi_c(\cdot)$ satisfies the Nyquist criterion with respect to T_c . Classic amplitude shift keying (ASK), frequency-shift keying (FSK), phase shift keying (PSK) could be applied for generating $x_c(n)$.

The model here is a single-carrier system, which has limitation in bandwidth and data rates. Following a 1965 article, Zimmerman and Kirsch designed a high frequency radio multi-carrier transceiver [12]. When the structure in signal space relies on multiple subcarriers, it corresponds to a multi-carrier scheme which is represented by $s_c(t) = \sum_{n=0}^{N_s-1} \sum_{m=0}^{N_c-1} x_{c,m}(n) \psi_{c,m}(t - nT_c) e^{j2\pi f_c t}$. Here $x_{c,m}(n)$ is the symbol sequence being transmitted, N_c is the number of subcarriers, and $\psi_{c,k}(t)$ is the synthesis function which satisfies the Nyquist criterion with respect to $\frac{1}{B_c}$ and maps $x_{c,m}(n)$ into the signal space. The family of $\psi_{c,m}(t) = \omega_c(t) e^{j2\pi m \Delta f t}$ is referred to as a Gabor system, where $\omega_c(t)$ is the prototype filter, and Δf is the subcarrier spacing. It is easy to show that an N_c -point inverse discrete Fourier transform (IDFT) operating on the data generates samples of the OFDM signal, which can be accelerated by the fast Fourier transform (FFT) algorithm proposed by J. W. Cooley and J. W. Tukey [13].

C. Interplay between R&C - SP on Different Domains

1) *OFDM-based Radar Sensing:* The above subsection has introduced the signal model and processing techniques for R&C systems, which are essentially processing in the time-frequency domain. It is worth noting that the OFDM signal can also be used for radar sensing, and it is an example of the communication-centric ISAC waveforms that will be elaborated later. In such a system, the ISAC Tx transmits signals jointly for radar sensing and communicating with communication users by using a unified OFDM signal, where each symbol is individually modulated with data belonging to a constellation. The OFDM blocks are individually processed at the Rx of the ISAC system. While the communication processing consists of extracting modulated data from each block, the radar processing consists of estimating the delay-Doppler (DD) profile through the 2D-FFT operation [14].

2) *Delay-Doppler Domain Communications:* The recently developed orthogonal time-frequency space (OTFS) modulation proposed to use DD-based signal representation to convert the time-frequency channel responses into simple 2D time-invariant responses [15], via the use of the symplectic finite Fourier transform (SFFT) and its inverse (ISFFT). Information-conveying pulses are placed into each DD grid. Note that a general OTFS channel estimation strategy can also be regarded as a target sensing process, where a pilot symbol is placed at $(0, 0)$ of the DD grid and then transformed into the time-frequency domain via 2D-ISFFT. The DD channel response circularly convolves with the pilot, and is processed at the Rx. The exact localization of the 2D peak is estimated to generate a DD profile for targets.

IV. SCALING UP THE ANTENNA ARRAY: THE ROAD FROM SINGLE ANTENNA TO MASSIVE MIMO

In the last decade, the evolution of both R&C systems has gained considerable spatial efficiency by scaling up the antenna arrays. The more antennas equipped at Tx/Rx, the more degrees of freedom (DoFs) that signaling strategies can

be exploited from the propagation channel, and the better reliability can be achieved in the transmission. In this section, we investigate the evolution path of the array structure.

A. Array Structure Evolution and Signal Models

In general, an antenna array can be described by its response, a.k.a. steering vector, which is a vector function of angle parameters θ , denoted as $\mathbf{a}(\theta)$. For an N -antenna uniform linear array (ULA) with antenna spacing d and wavelength λ , the steering vector is expressed as

$$\mathbf{a}(\theta) = \left[1, e^{-j2\pi\frac{d}{\lambda}\sin(\theta)}, e^{-j4\pi\frac{d}{\lambda}\sin(\theta)}, \dots, e^{-j(N-1)\pi\frac{d}{\lambda}\sin(\theta)} \right], \quad (7)$$

where $\theta \in [-\pi/2, \pi/2]$, and d is typically set as $\lambda/2$. Suppose that the radar or communication system is equipped with N_t and N_r antennas at its Tx and Rx, and that the signal arrives from L resolvable paths. the general channel matrix for both R&C can be modeled as

$$\mathbf{H} = \sum_{l=1}^L \alpha_l \mathbf{b}(\theta_l) \mathbf{a}^T(\phi_l) \quad (8)$$

where α_l , ϕ_l , and θ_l are the channel coefficient, direction of departure (DoD), and direction of arrival (DoA) for the l th signal path, $\mathbf{a}(\phi) \in \mathbb{C}^{N_t \times 1}$ and $\mathbf{b}(\theta) \in \mathbb{C}^{N_r \times 1}$ are Tx and Rx steering vectors, respectively. The channel model (8) represents L resolvable point targets for radar, and L propagation paths for communication. In the communication case, α_l is contributed by both the path-loss and the small-scale fading effect. In the radar case, α_l may also be contributed by the radar cross-section (RCS) of the targets in addition to the round-trip path-loss, which follows the Swerling's target models [16].

Phased Array: Having the capability of generating highly directive beam through rapid electronic phase control, phased-array techniques triggered various R&C innovations. The phased array system, in its simplest form, consists of a single RF chain connected with multiple antennas through phase shifters. In other words, the signal transmitted over each antenna is a phase-shifted counterpart of the signal generated in the RF chain. If both the Tx and Rx are equipped with phased arrays, the discrete receive signal at time instant n can be expressed as

$$\mathbf{y}_n = \mathbf{w}^H \mathbf{H} \mathbf{f} s_n + \mathbf{z}_n, \quad \forall n, \quad (9)$$

where s_n is the signal transmitted within the Tx's RF chain, $\mathbf{f} \in \mathbb{C}^{N_t \times 1}$ and $\mathbf{w} \in \mathbb{C}^{N_r \times 1}$ consist of the phase-shifters at the Tx and Rx, with each of their entries being constant-modulus (CM), which are also known as the transmit beamformer and receive combiner, and are referred to as RF/analog beamforming.

MIMO (Digital) Array: In contrast to the phased array, the MIMO system is equipped with multiple RF chains, where each RF chain is connected to a single antenna port. The receive signal for a MIMO system can be modeled as

$$\mathbf{y}_n = \mathbf{H} \mathbf{F} s_n + \mathbf{z}_n, \quad \forall n, \quad (10)$$

where $\mathbf{s}_n \in \mathbb{C}^{K \times 1}$ and $\mathbf{y}_n \in \mathbb{C}^{N_r \times 1}$ are transmit and receive signal vectors at the Tx and Rx, respectively, with

K being the number of independent signals, and $\mathbf{F} \in \mathbb{C}^{N_t \times K}$ a digital precoder. In MIMO radar applications, $\mathbf{s}_n, \forall n$ are spatially orthogonal waveforms, and \mathbf{F} may be designed to steer the signals to multiple directions simultaneously, or to keep the orthogonality for omni-directional searching. In MIMO communication applications, \mathbf{F} may be designed to equalize or exploit the multi-path effect using various precoding techniques, e.g., zero-forcing (ZF) and MF precoding. MIMO communication technology was first patented in 1994 [17], which inspired the invention of the MIMO radar concept in 2003 [18].

Massive MIMO (mMIMO) Array: When the antenna number grows extremely large, e.g., above 100, the MIMO system becomes an mMIMO system, or a large-scale antenna system. In this case, the steering vectors are asymptotically orthogonal to each other. Moreover, in a richly scattering environment with large L , for $N_t \rightarrow \infty, N_t \gg N_r$, we have $\text{var}(\|\mathbf{h}_k\|^2) / \mathbb{E}(\|\mathbf{h}_k\|^2) \rightarrow 0, \forall i$, and $\frac{1}{N_t} \mathbf{H} \mathbf{H}^H \approx \mathbf{I}_{N_r}$, which are known as the *channel hardening* and *favorable propagation* effects. While the basic signal model for mMIMO remains the same to (10), it has additional superiorities over small-scale MIMO [3]. First, it provides even more DoFs. More importantly, the channel hardening effect improves the communication reliability by generating a nearly deterministic channel, which considerably simplifies the signal processing. Recent research also revealed that the mMIMO radar is able to detect a target via a single snapshot in the presence of disturbance with unknown statistics [19].

Hybrid Array: Massive MIMO achieves dramatic gains at the price of growing number of antennas and RF chains, incurring significant hardware costs that are unaffordable for practical implementations, especially for systems operated at the mmWave band. To that end, the hybrid analog-digital array was proposed as a promising solution [20]. The hybrid array can be viewed as a tradeoff between the phased-array and fully-digital MIMO array, as it connects fewer RF chains with massive antennas through phase-shifters or switches. Consider a hybrid array with N_{RF} RF chains and N_t antennas. The phase-shifter based design has the following signal model

$$\mathbf{y}_n = \mathbf{H} \mathbf{F}_{RF} \mathbf{F}_{BB} s_n + \mathbf{z}_n, \quad \forall n, \quad (11)$$

where $\mathbf{F}_{RF} \in \mathbb{C}^{N_t \times N_{RF}}$ is the analog beamforming matrix containing constant-modulus entries representing phase-shifters, and $\mathbf{F}_{BB} \in \mathbb{C}^{N_{RF} \times K}$ is a digital precoder multiplexing K data streams. The hybrid array is also known as the phased-MIMO structure in the radar community [21]. In addition to reducing the cost for implementing the MIMO radar, it achieves a balance between phased-array and MIMO radars via harvesting performance gains from both. By partitioning the antenna array into different sub-arrays, phased-MIMO radar may formulate highly directional beams towards targets at each sub-array, improving the SNR of the echoes. In the meantime, it may also transmit orthogonal waveforms over different sub-arrays, thus to reap the gain of waveform diversity.

Distributed Array: The continually growing demands for connectivity, coverage, and high-resolution sensing necessitate the research of the distributed antenna array system for both

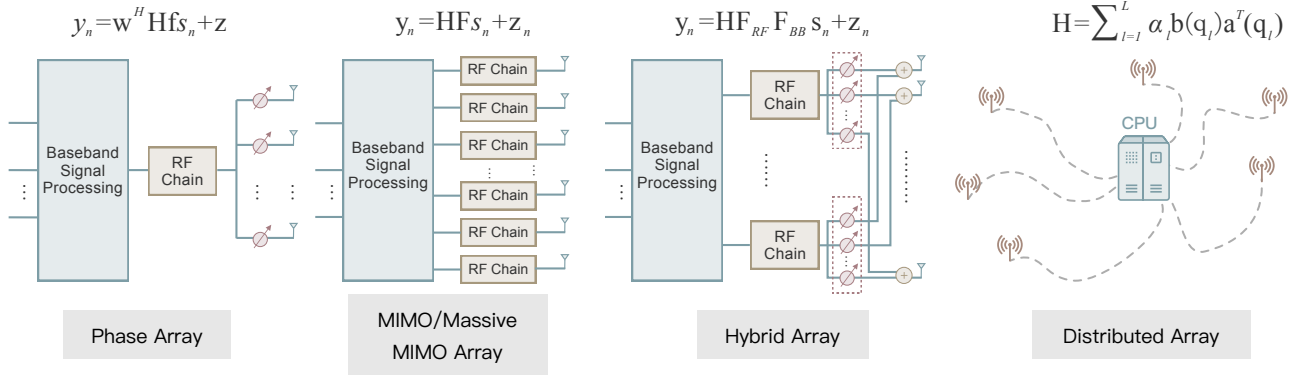

Fig. 3. Antenna array evolution and signal models.

R&C. Instead of colocating the antennas in a compact space, distributed antennas are spread over a large area while connecting to a central processing unit (CPU), providing much higher probability of coverage and improved diversity gain. Distributed antenna systems have been extensively studied from the communication viewpoint under different names, including coordinated multi-point (CoMP) and cell-free mMIMO [22]. Its radar counterparts, on the other hand, are known as multi-static radar, and MIMO radar with widely separated antennas [23]. The distributed array may also be described by its response, which, however, is no longer a function of the angle, rather it is a function of the coordinates of the targets or scatterers in each signal path. By denoting the coordinates of the l th target/scatterer as $\mathbf{q}_l = (x_l, y_l)$, the distributed channel matrix can be expressed as

$$\mathbf{H} = \sum_{l=1}^L \alpha_l \mathbf{b}(\mathbf{q}_l) \mathbf{a}^T(\mathbf{q}_l). \quad (12)$$

Note that the specific geometry of arrays rely upon the overall deployment of the distributed system.

B. Interplay between R&C - Multiplexing vs. Diversity

The expansion of the antenna array brings diversity and multiplexing gains, which are cornerstones of MIMO communication theory. Transmit or receive diversity is a means to combat deep fading by creating different propagation paths through the Tx-Rx antenna pairs. Multiplexing, on the other hand, *exploits* the fading effect by sending different data streams over independently faded subchannels. In 2003, L. Zheng and D. Tse revealed that there is an inherent tradeoff between the two gains, namely, diversity-multiplexing tradeoff (DMT) [24]. For an i.i.d. Rayleigh MIMO channel $\mathbf{H}_c \in \mathbb{C}^{N_r \times N_t}$, the maximum diversity gain and multiplexing gain is $N_t N_r$ and $\min\{N_t, N_r\}$, respectively. From a broader viewpoint, DMT is essentially a tradeoff between reliability and efficiency.

The spirit of MIMO radar signal processing can be interpreted in a similar manner. On one hand, colocated MIMO radar possesses the superior attribute of *waveform diversity*, which means that diverse waveforms are flexibly emitted through different antennas. This significantly improves the

parameter identifiability compared to its phased-array counterpart. That is, the colocated MIMO radar is able to uniquely identify up to $\mathcal{O}(N_t N_r)$ targets, which is N_t times of that of the phased-array radar [2]. This connects more closely to the multiplexing gain in communications. On the other hand, distributed MIMO radar provides the *target RCS diversity*. By widely spreading the antennas, distributed MIMO radar is able to observe a target from different directions, thus to provide a stable sensing performance by overcoming the drastic RCS fluctuations in high-mobility targets [23].

The above discussion reflects again the signals-and-systems duality. Since the signals and systems are interchangeable, we may view radar target channels as “signals”, and radar waveforms as “systems”. While the basic model for MIMO communications is that multiple data streams (signals) are transmitted through multiple spatial channels (systems), the model for MIMO radar is, conversely, that multiple target channels (signals) pass through diverse waveforms (systems). This duality creates the interesting interplay between R&C, and may imply more essential connections and tradeoffs in ISAC systems.

V. INTEGRATED SENSING AND COMMUNICATIONS: THE ROAD FROM SEPARATION TO INTEGRATION

A. ISAC: From Competitive Coexistence to Co-design

The ubiquitous deployment of R&C systems leads to severe competition over various resource domains. To date, both technologies exhibit explosively growing demands for spectral and spatial resources, and are thus evolving towards higher frequencies and larger antenna arrays. As exemplified in Sec. III-A, a variety of R&C systems have to cohabit within multiple frequency bands, which, inevitably, incurs significant mutual interference between the two functionalities [25]. To ensure harmonic coexistence between R&C, orthogonal resource allocation became a viable approach. Nevertheless, orthogonal allocation results in low resource efficiency for both R&C. Aiming for fully excavating the potential of the limited wireless resources, and to enable the co-design of the R&C functionalities, ISAC was proposed as a key technology for both next-generation wireless networks and radar systems.

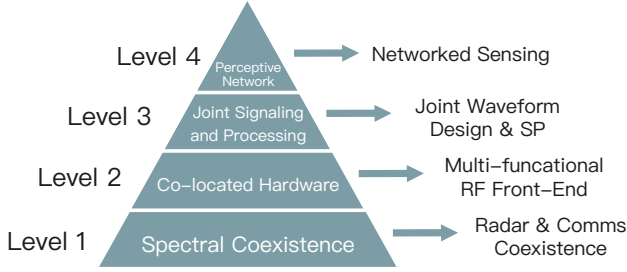

Fig. 4. Evolution path for ISAC technologies.

The technological vision of ISAC can be divided into four levels, as shown in Fig. 4. The first level is to share the spectral resources between individual R&C systems without interfering with each other. At the second level, the R&C functionalities may be deployed on the same hardware platform. At the third level, wireless resources may be fully reused between R&C via a common waveform, a single transmitting device, and a unified signal processing framework. Finally, at the fourth level, both R&C can share a common networking infrastructure, constructing a *perceptive network* to serve for both sensing and communications functionalities. This underpins a large number of emerging IoT, 5G-Advanced and 6G applications that require high-quality communication, sensing, and localization services [4].

During the past three decades, the development of ISAC has been supported by a number of governmental projects worldwide, among which the most influential ones are the “Advanced Multifunction Radio Frequency Concept (AMRFC)” program initiated by the Office of Naval Research (ONR) of the US in the 1990s, and the “Shared Spectrum Access for Radar and Communications (SSPARC)” project funded by the Defense Advanced Research Projects Agency (DARPA) of the US in the 2010s [4]. Most of the technical outcome of these projects formulating the Level-1 to Level-2 ISAC approaches. In the 2020s, networked ISAC (Level 3 to Level-4) was recognized by major enterprises in the communications industry as one of the core air interface technologies for Wi-Fi-7, 5G-Advanced and 6G [4].

To fully realize the promise of the ISAC technology, advanced SP techniques are indispensable. In this section, we briefly review the recent research progress on the SP for ISAC. In particular, we focus on the Level-3 and 4 where a unified signaling strategy is designed to serve for the dual purposes of R&C.

B. ISAC Signal Processing

Without loss of generality, we investigate the linear Gaussian models considered in Sec. II. The only difference is that a unified ISAC signal \mathbf{S} is employed for both R&C, leading to

$$\begin{aligned} \text{Radar Signal Model: } \mathbf{Y}_r &= \mathbf{H}_r(\boldsymbol{\eta}) \mathbf{S} + \mathbf{Z}_r \\ \text{Comms Signal Model: } \mathbf{Y}_c &= \mathbf{H}_c \mathbf{S} + \mathbf{Z}_c, \end{aligned} \quad (13)$$

where \mathbf{S} is a discrete representation of the ISAC signal. We highlight that (13) are abstractions for many existing

ISAC models. That is, an ISAC Tx transmits a signal \mathbf{S} to communicate information while detecting targets. For radar sensing applications, the radar Rx observes \mathbf{Y}_r , and wishes to extract an estimate of $\boldsymbol{\eta}$ with the knowledge of the reference waveform \mathbf{S} , which is known to both the ISAC Tx and radar Rx, as discussed in Sec. II-B. For communication applications, on the other hand, the communication Rx observes \mathbf{Y}_c , and wishes to recover \mathbf{S} , which is unknown to the communication Rx.

A generic ISAC SP framework is shown in Fig. 5, where the R&C functionalities are jointly coordinated at the ISAC Tx to form a baseband ISAC signal. After being up-converted to the RF band, the signal propagates through the R&C channels and arrives at the Rx. The received signal, which may consist of both target and communication information, first goes through a pre-processing procedure including synchronization, separation, filtering and transformation, and is then processed following the regular R&C SP pipelines. ISAC SP is rather different from the individual R&C SP. That is, when the wireless resources are shared between R&C, there exists an intrinsic *performance tradeoff* as their design objectives are distinct or even contradictory to each other. As shown in Fig. 6, such a tradeoff can be framed as the Pareto frontier in terms of different R&C performance metrics, e.g., radar’s CRB and communication rate. The complete characterization of such a Pareto frontier still remains wide open. The two corner points, P_{CS} and P_{SC} , represent the communication-optimal and radar-optimal performance, with the corresponding achievable rate-CRB pairs denoted by (C_{CS}, ϵ_{CS}) and (C_{SC}, ϵ_{SC}) , respectively. This results in three categories of ISAC SP designs, i.e., communication-centric, radar-centric, and joint design, which target on approaching the points P_{CS} and P_{SC} , and the Pareto frontier in between, respectively.

1) *Communication-Centric Design*: Communication-centric design (CCD) simply implements the radar sensing functionality over an existing or even commercialized communication waveform, in which case the communication functionality has the priority. The most representative CCD approach is the OFDM-based ISAC signaling, which directly exploits the OFDM communication waveform to simultaneously accomplish R&C tasks [14]. Assume that the ISAC Tx emits the OFDM signal to communicate with a user, while sensing a point target with delay τ and Doppler ν . After receiving the echo signal reflected from the target, the radar Rx, which is colocated with the ISAC Tx, samples at each OFDM symbol, followed by a block-wise FFT processing. The resultant discrete signal can be arranged into a matrix, with its (n, m) -th entry associating with the n th symbol at the m th subcarrier, given as

$$y_{n,m} = \alpha_{n,m} x_{n,m} e^{-j2\pi(m-1)\Delta f\tau} e^{j2\pi\nu(n-1)T_c} + z_{n,m}, \quad (14)$$

where $\alpha_{n,m}$ and $z_{n,m}$ are the channel coefficient and noise. The random communication data $x_{n,m}$ impose a negative impact on radar sensing, which can be simply mitigated by element-wise division

$$\tilde{y}_{n,m} = \frac{y_{n,m}}{x_{n,m}} = \alpha_{n,m} e^{-j2\pi(m-1)\Delta f\tau} e^{j2\pi\nu(n-1)T_c} + \frac{z_{n,m}}{x_{n,m}}. \quad (15)$$

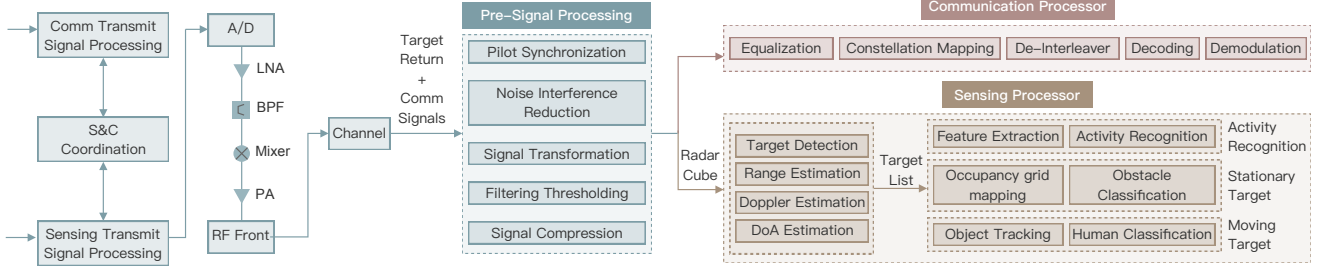

Fig. 5. General signal processing framework for ISAC systems.

Then, a 2D-FFT can be applied to (15) to get the DD profile of the target.

2) *Radar-Centric Design*: In contrast to CCD schemes, radar-centric design (RCD) aims at implementing the communication capability over existing radar infrastructures, targeting on approaching the performance at P_{SC} . Since the classical radar waveform contains no information, RCD schemes are also referred to as information embedding approaches in the literature, namely, the communication data is embedded into the radar waveform, in a way that will not unduly degrade the sensing performance. Early RCD schemes have mainly focused on exploiting the LFM signal as an information carrier [26]. In addition to the conventional modulation formats including amplitude, phase, and frequency shift keyings, LFM signals have another design DoF, i.e., the slope that the frequency increases with the time, which may also be utilized for data embedding. To fully guarantee the radar performance, recent research proposed to realize ISAC by *index modulation (IM)*, which was first proposed in [27] for MIMO radar transmitting orthogonal waveforms. In such a case, the communication information was conveyed by shuffling the waveforms across multiple antennas, which does not break the orthogonality. As a step forward, more recent RCD schemes implement IM-based ISAC signaling on the carrier-agile phased array radar (CAESAR), namely, the multi-carrier agile joint radar-communication (MAJoRCom) system [28]. During each PRI, the MAJoRCom randomly selects the carrier frequencies from a frequency set, and randomly allocates these frequencies to each antenna, which again keeps the orthogonality unaffected.

3) *Joint Design*: As discussed above, CCD and RCD schemes attempt to approach the performance of P_{CS} and P_{SC} , which may be implemented in existing communication and radar systems, respectively. However, they lack the flexibility to formulate a scalable tradeoff between R&C, or, equivalently, to approach the performance of an arbitrary point on the Pareto frontier in Fig. 6. To resolve this issue, joint design (JD) based ISAC signaling becomes a promising strategy, which are often conceived through convex optimization techniques [29]. Consider a MIMO ISAC BS that serves K_u single-antenna users while detecting a point target locating at an angle θ . A ISAC signal \mathbf{S} constrained by the energy E_T can be obtained by solving the below angle CRB minimization problem under

the sum-rate constraint

$$\min_{\mathbf{S}} \text{CRB}(\theta) \quad \text{s.t.} \quad \sum_{k=1}^{K_u} R_k \geq R_0, \forall k, \quad \|\mathbf{S}\|_F^2 \leq E_T, \quad (16)$$

where R_k is the achievable rate for the k th user, and R_0 is a pre-defined sum-rate threshold. The Pareto frontier between R&C can be obtained by increasing R_0 , which leads to increased objective CRB.

C. Interplay between R&C - Fundamental Tradeoff

From the above ISAC SP strategies, it is interesting to note that there is a two-fold tradeoff between R&C, namely, *deterministic vs. random tradeoff (DRT)* and *subspace tradeoff (ST)*.

1) *Deterministic vs. Random Tradeoff*: Communication systems require random signals to convey as much information as possible, whereas radar systems prefer deterministic signals for achieving stable sensing performance. This has been an intuitive insight consistent with both the engineers' experience and R&C SP theory. For instance, constellation shaping for communications always target on approximating a Gaussian distribution, thus to approach the Shannon capacity. Radar systems, on the other hand, prefer to transmit CM waveforms at the maximum available power budget, which motivates the use of phase-coded signals. For clarity, this concept has been shown in Fig. 6.

The DRT has also been reflected in the above CCD and RCD approaches. For OFDM-based CCD signaling, the element-wise division of the random data changes the statistical characteristics of the noise across the symbols and subcarriers, imposing performance loss to the thresholding and peak detection in the 2D-FFT processing. To tackle this issue, a natural idea is to transmit PSK modulated data, which only rotates the phase of the circularly symmetric Gaussian noise without changing its distribution. For IM-based RCD scheme, the radar transmits communication data by the random selections of waveforms across the antennas, i.e., the information is carried by permutation or selection matrices, while keeping the radar waveform orthogonality unchanged. In both cases, the communication rate can be increased by embedding more random data (exploiting more DoFs) into the ISAC signal, which is however at the price of deteriorated radar sensing performance.

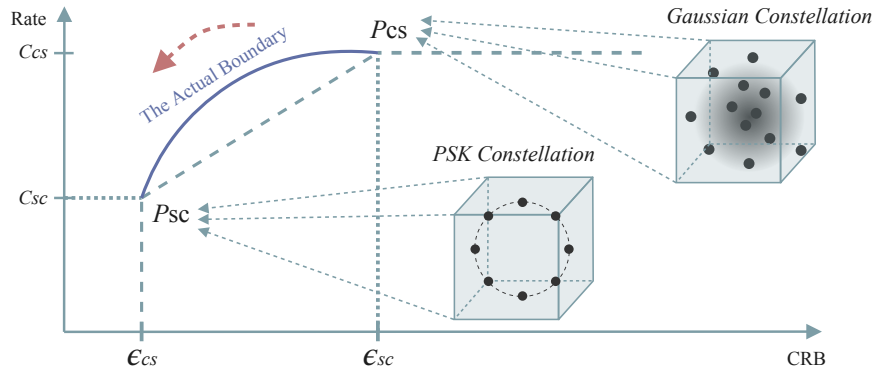

Fig. 6. Performance tradeoff between R&C.

2) *Subspace Tradeoff*: Another fundamental tradeoff in ISAC is the subspace tradeoff. The column vectors of R&C channel matrices $\mathbf{H}_r, \mathbf{H}_c$ span the sensing and communication subspaces. In order to fully radiate the transmit power towards targets/users, radar-optimal and communication-optimal signals should align to the two subspaces, respectively. Consequently, the R&C performance can be balanced in an ISAC system by allocating resources into the two subspaces. Apparently, if two subspaces are partially overlapped, then resources allocated to the intersection are shared between R&C, improving the efficiency. On the contrary, if two subspaces are orthogonal to each other, no resources can be reused, leading to zero performance gain. Based on the overlapped degree of two subspaces, one may categorize R&C channels as weakly coupled, moderately coupled, and strongly coupled scenarios, which are intuitively illustrated in Fig. 7. The higher coupling degree between two subspaces results in better tradeoff performance, as more resources are reused between R&C.

The ST can be observed in the JD signaling scheme discussed in (16). That is, by increasing the communication sum-rate threshold R_0 , more signal power is transmitted towards the directions of communication users, while less power is radiated to sense the target, resulting in a higher CRB.

VI. OPEN CHALLENGES AND FUTURE RESEARCH DIRECTIONS

Although ISAC has been well-investigated from various facets in recent years, there are still lots of open challenges that remain widely unexplored. Here we overview some of the open problems in fundamental tradeoff, signal processing, and networking aspects, where tremendous research efforts are needed.

1) *Full Characterization of the ISAC Performance Tradeoff*: Characterizing the ISAC performance tradeoff is a multi-objective functional optimization problem by its nature. Nevertheless, the current results are only able to depict the performance at the two corner points [30]. It is unclear where the exact Pareto frontier lies in Fig. 6, and what are the optimal signaling strategies to achieve that boundary.

2) *Practical ISAC Signal Processing*: Most of the current ISAC signaling schemes were proposed under ideal assumptions. However, there are a large number of practical constraints that prevent the implementation of these ISAC designs. For instance, CCD approaches that adopt standardized communication waveform, e.g., 5G NR, face the challenges of insufficient bandwidth and high peak-to-average power ratio (PAPR), which leads to severe performance loss of radar sensing.

3) *Networked ISAC*: The current state-of-the-art research mainly concentrates on the SP for single-node ISAC systems. To realize networked ISAC using the commercialized networking infrastructures, which are not originally tailored for radar sensing, a series of SP challenges need to be carefully coped with. For instance, clock-level network synchronization is needed to achieve high sensing accuracy. Moreover, in order to detect short-range targets, e.g., humans and vehicles, the future ISAC BS should operate in full-duplex mode to avoid self-interference between the transmit signal and target return.

VII. CONCLUSION

In this paper, we have overviewed the technological evolution of R&C from an SP viewpoint. We first focused our discussion on the general principles and fundamental SP techniques for both R&C. After that, we introduced the two main trends and the resulting signal processing schemes in the historical development of R&C, namely, the increase of the frequencies and bandwidths, and the expansion of the antenna arrays. Following these two trends, we provided a detailed discussion on the recent progress of SP techniques for ISAC systems. Finally, we identified a number of major open challenges in the implementation of ISAC technologies.

Although being two long-established disciplines, the story of R&C will continue in the foreseeable future. We firmly believe that ISAC, the marriage between R&C, will shape the modern information society again in profound ways, just like they did in the past seven decades.

REFERENCES

- [1] L. Yang and G. Giannakis, "Ultra-wideband communications: an idea whose time has come," *IEEE Signal Process. Mag.*, vol. 21, no. 6, pp. 26–54, 2004.

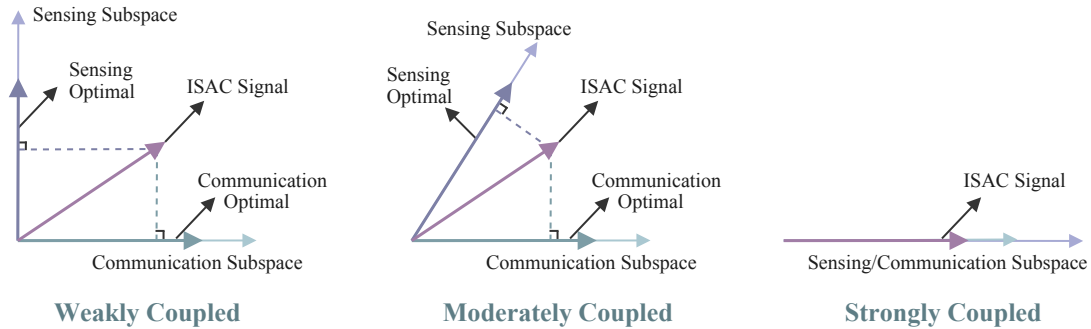

Fig. 7. Subspace tradeoff and coupling effect in ISAC systems.

- [2] J. Li and P. Stoica, "MIMO radar with colocated antennas," *IEEE Signal Process. Mag.*, vol. 24, no. 5, pp. 106–114, Sept. 2007.
- [3] T. L. Marzetta, "Noncooperative cellular wireless with unlimited numbers of base station antennas," *IEEE Trans. Wireless Commun.*, vol. 9, no. 11, pp. 3590–3600, Nov. 2010.
- [4] F. Liu, Y. Cui, C. Masouros, J. Xu, T. X. Han, Y. C. Eldar, and S. Buzzi, "Integrated sensing and communications: Toward dual-functional wireless networks for 6G and beyond," *IEEE J. Sel. Areas Commun.*, vol. 40, no. 6, pp. 1728–1767, 2022.
- [5] S. Kotz and N. L. Johnson, *Breakthroughs in Statistics: Foundations and basic theory*. Springer Science & Business Media, 2012.
- [6] C. E. Shannon, "A mathematical theory of communication," *The Bell Syst. Tech. J.*, vol. 27, no. 3, pp. 379–423, 1948.
- [7] P. M. Woodward, *Probability and information theory, with applications to radar*. Elsevier, 2014.
- [8] D. Guo, S. Shamai, and S. Verdú, "Mutual information and minimum mean-square error in Gaussian channels," *IEEE Trans. Inf. Theory*, vol. 51, no. 4, pp. 1261–1282, 2005.
- [9] H. Griffiths *et al.*, "Radar spectrum engineering and management: Technical and regulatory issues," *Proc. IEEE*, vol. 103, no. 1, pp. 85–102, 2015.
- [10] K. Ruttenberg and L. Chanzit, "High range resolution by means of pulse to pulse frequency shifting," *IEEE Eascon Record*, pp. 47–51, 1968.
- [11] Y. C. Eldar and G. Kutyniok, *Compressed sensing: theory and applications*. Cambridge university press, 2012.
- [12] M. Zimmerman and A. Kirsch, "The AN/GSC-10 (KATHRYN) variable rate data modem for hf radio," *IEEE Trans. Commun.*, vol. 15, no. 2, pp. 197–204, 1967.
- [13] J. W. Cooley and J. W. Tukey, "An algorithm for the machine calculation of complex fourier series," *Math. Comput.*, vol. 19, no. 90, pp. 297–301, 1965.
- [14] C. Sturm and W. Wiesbeck, "Waveform design and signal processing aspects for fusion of wireless communications and radar sensing," *Proc. IEEE*, vol. 99, no. 7, pp. 1236–1259, Jul. 2011.
- [15] R. Hadani and A. Monk, "OTFS: A new generation of modulation addressing the challenges of 5G," *arXiv preprint arXiv:1802.02623*, 2018.
- [16] P. Swerling, "Probability of detection for fluctuating targets," *IRE Trans. Inf. Theory*, vol. 6, no. 2, pp. 269–308, 1960.
- [17] A. J. Paulraj and T. Kailath, "Increasing capacity in wireless broadcast systems using distributed transmission/directional reception (DTDR)," Sept. 1994, US Patent 5,345,599.
- [18] D. Bliss and K. Forsythe, "Multiple-input multiple-output (MIMO) radar and imaging: Degrees of freedom and resolution," in *Proc. Asilomar*, vol. 1, 2003, pp. 54–59.
- [19] S. Fortunati, L. Sanguinetti, F. Gini, M. S. Greco, and B. Himed, "Massive MIMO radar for target detection," *IEEE Trans. Signal Process.*, vol. 68, pp. 859–871, Jan. 2020.
- [20] O. E. Ayach, S. Rajagopal, S. Abu-Surra, Z. Pi, and R. W. Heath, "Spatially sparse precoding in millimeter wave MIMO systems," *IEEE Trans. Wireless Commun.*, vol. 13, no. 3, pp. 1499–1513, Mar. 2014.
- [21] H. Q. Ngo, A. Ashikhmin, H. Yang, E. G. Larsson, and T. L. Marzetta, "Cell-free massive MIMO versus small cells," *IEEE Trans. Wireless Commun.*, vol. 16, no. 3, pp. 1834–1850, 2017.
- [22] A. M. Haimovich, R. S. Blum, and L. J. Cimini, "MIMO radar with widely separated antennas," *IEEE Signal Process. Mag.*, vol. 25, no. 1, pp. 116–129, 2008.
- [23] L. Zheng and D. Tse, "Diversity and multiplexing: A fundamental tradeoff in multiple-antenna channels," *IEEE Trans. Inf. Theory*, vol. 49, no. 5, pp. 1073–1096, 2003.
- [24] L. Zheng, M. Lops, Y. C. Eldar, and X. Wang, "Radar and communication coexistence: An overview: A review of recent methods," *IEEE Signal Process. Mag.*, vol. 36, no. 5, pp. 85–99, 2019.
- [25] G. N. Saddik, R. S. Singh, and E. R. Brown, "Ultra-wideband multifunctional communications/radar system," *IEEE Trans. Microw. Theory Technol.*, vol. 55, no. 7, pp. 1431–1437, Jul. 2007.
- [26] E. BouDaher, A. Hassanien, E. Aboutanios, and M. G. Amin, "Towards a dual-function MIMO radar-communication system," in *Proc. IEEE Radar Conf. (RadarConf)*, May 2016, pp. 1–6.
- [27] T. Huang, N. Shlezinger, X. Xu, Y. Liu, and Y. C. Eldar, "MAJoRCom: A dual-function radar communication system using index modulation," *IEEE Trans. Signal Process.*, vol. 68, pp. 3423–3438, 2020.
- [28] F. Liu, Y.-F. Liu, A. Li, C. Masouros, and Y. C. Eldar, "Cramér-Rao bound optimization for joint radar-communication beamforming," *IEEE Trans. Signal Process.*, vol. 70, pp. 240–253, 2022.
- [29] Y. Xiong, F. Liu, Y. Cui, W. Yuan, and T. X. Han, "Flowing the information from Shannon to Fisher: Towards the fundamental tradeoff in ISAC," in *Proc. IEEE Global Commun. Conf. (GLOBECOM)*, Dec. 2022, pp. 1–6.